



9W Bulb Lamp LED Driver Module with the Active Power Factor Correction

AC Input Voltage Range	LED DC Output Voltage/Current	Output Power
90V _{AC} /60Hz ~ 264(300 ^{**})V _{AC} /50Hz	52V/160mA	8.32W

** - Change the CX1 form 104/275V to 104/340V to increase input range to 300V_{AC}

Key Features

- Universal input from 90V_{AC}/60Hz to 264(300^{**})V_{AC}/50Hz, LED DC 52V/160mA output
- One cycle control Power Factor Correction (PFC) and typical PF value > 0.97 @110V_{AC} and PF>0.92@220V_{AC}
- Fixed frequency buck converter and maximum efficiency : 90%
- LED output current variation :
 - ±2% for Full range (90-264V_{AC})
 - ±1% for Low Voltage(90-132V_{AC})
 - ±1% High Voltage(180-264V_{AC})
- Dimension : 45mm×24mm×19mm
- Typical application : Bulb lamps

Introduction

This application note describes a constant current bulb lamp power module with one cycle control active power factor correction for full range input voltage from 90V_{AC} ~ 264(300^{**})V_{AC} by adopting the SQ6211. Based on buck PFC topology, the SQ6211 is able to achieve high power factor value for bulb lighting application. This application provides multiple advanced fault protections to enhance the systems safety, including natural Open Loop Protection (OLP), Short Circuit Protection (SCP), V_{DD} under-voltage lockout and thermal shut down. All protections have auto-restart mechanisms. Schematics, PCB Gerber, BOM, as well as typical performance are covered in details by this application note. A complete application circuit is depicted in Figure 5, which can work on universal input voltage range from 90V_{AC} ~ 264(300^{**})V_{AC}.

BOM

BOM is shown in Table 3.

PCB Layout

The PCB dimension is 45mm × 24mm × 1.6mm and Module dimension is 45mm × 24mm × 19mm in order to fit bulb lamp space.

Power Module Photo

Pictures of power module and key components are shown in Figure 6 and 7.

Specification

The Table 1 represents the specification that this design intends to achieve.

Performance

It is to drive output at 52V/160mA targeting to achieve high efficiency ($\eta_{MAX}=90\%$), high power factor (typical PF > 0.92) and current accuracy for AC universal input voltage range 90V_{AC}~264(300^{**})V_{AC}. Actual performance is shown on Table 2. Figure 1, 2, 3 and 4 depict power factor, output current, current variation and efficiency at AC input voltage range 90V_{AC} ~ 264(300^{**})V_{AC} for this module.



Table 1. Related Specification

Parameter	Symbol	Min.	Typ.	Max.	Unit	Note
AC input voltage	V _{AC}	90		264(300**)	V	
LED DC output voltage	V _{OUT}		52		V	
LED output current	I _{OUT(SET)}		160		mA	

Table 2. Actual Performance

AC Input	Input Power (W)	Output Current (I _{OUT} , mA)	Output Voltage (V _{OUT} , V)	Current Variation (%) ^(Note)	Efficiency (η, %)	PF
90V _{AC} /60Hz	9.11	158	52	-1.3	90.2	0.969
100V _{AC} /60Hz	9.12	158	52	-1.3	90.1	0.972
110V_{AC}/60Hz	9.14	159	52	-0.6	90.5	0.972
120V _{AC} /60Hz	9.14	159	52	-0.6	90.5	0.971
132V _{AC} /60Hz	9.14	159	52	-0.6	90.5	0.968
180V _{AC} /50Hz	9.20	160	52	0.0	90.4	0.949
200V _{AC} /50Hz	9.22	160	52	0.0	90.2	0.936
220V_{AC}/50Hz	9.24	160	52	0.0	90.0	0.921
240V _{AC} /50Hz	9.29	161	52	0.6	90.1	0.902
264(300**)V _A c/50Hz	9.33	161	52	0.6	89.7	0.876

Note :

Current Variation is defined as follows :

$$\% = \frac{I_{OUT} - I_{OUT(SET)}}{I_{OUT(SET)}} \times 100\%$$

where I_{OUT(SET)} = 160 mA

SEQUOIA CONFIDENTIAL



Figure 1. Power Factor for AC Input Voltage Range 90V_{AC} ~ 264V_{AC}

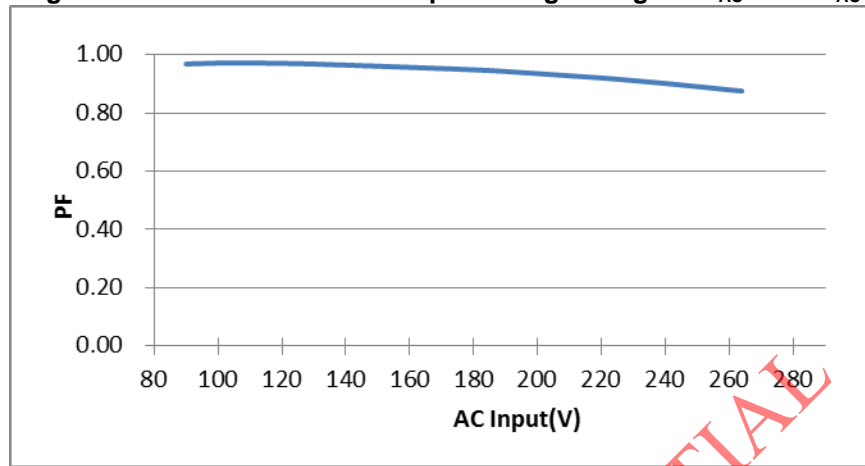

Figure 2. Output Current for AC Input Voltage Range 90V_{AC} ~ 264V_{AC}

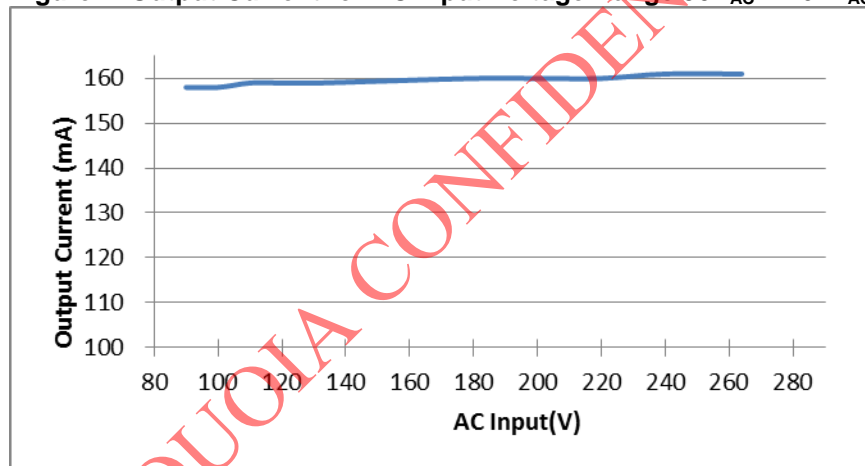

Figure 3. Current Variation for AC Input Voltage Range 90V_{AC} ~ 264V_{AC}

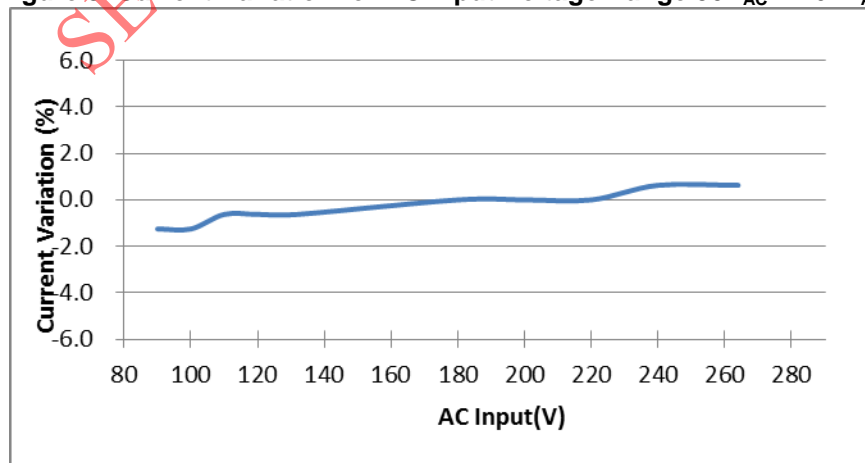

Figure 4. Efficiency for AC Input Voltage Range 90V_{AC} ~ 264V_{AC}

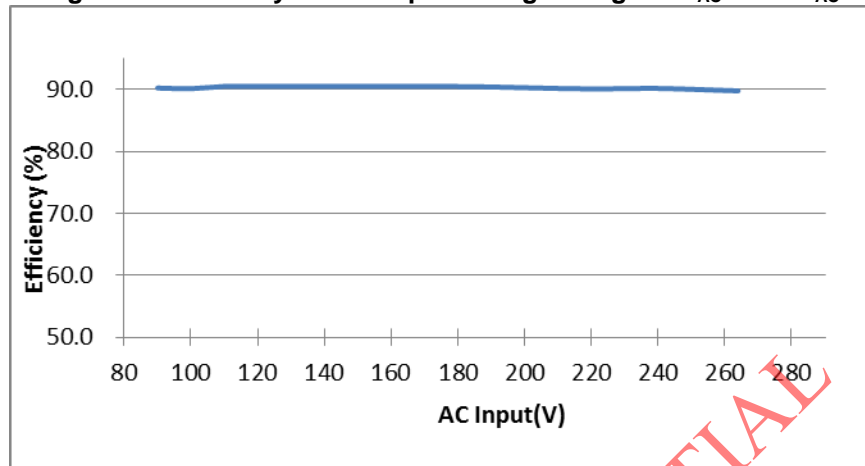

Figure 5. A Complete Application Circuit by Adopting the SQ6211

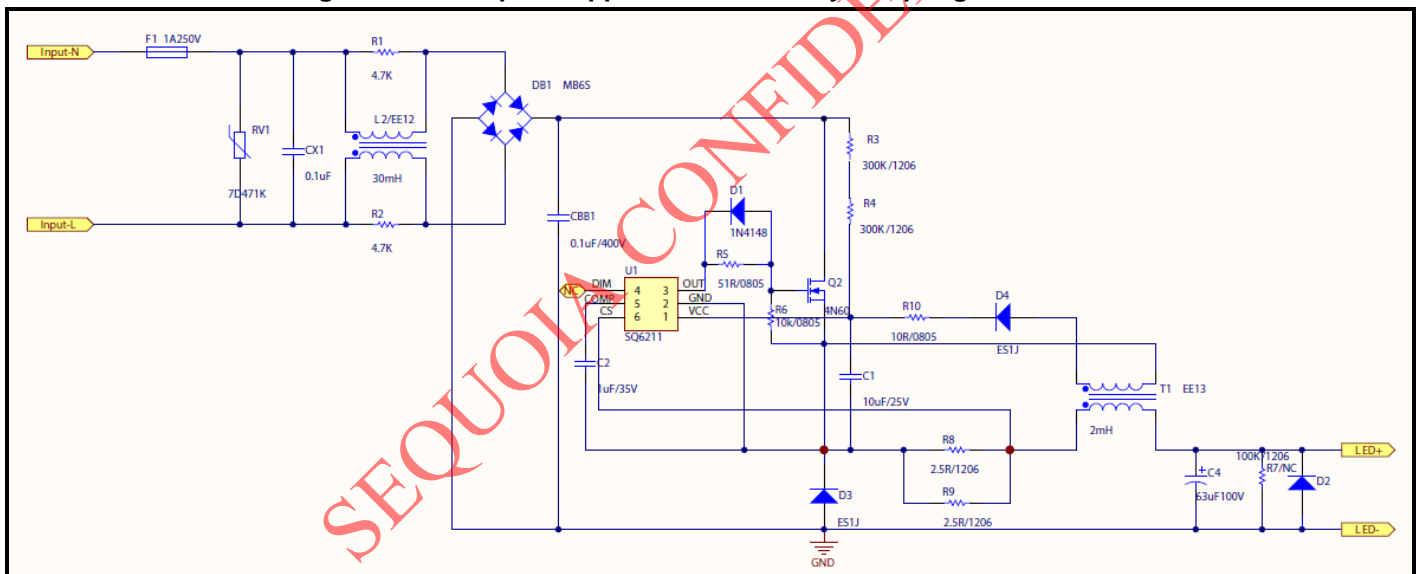
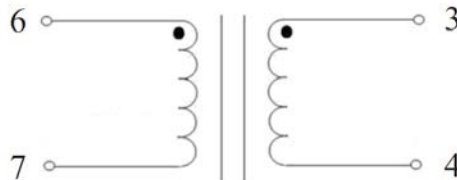



Table 3 : Bill of Material

Item	Symbol	Description	Category	Qty	Note
1	R1 R2	4.7K/0805/J	Resistor	2	
2	R3 R4	300k/1206/F	Resistor	2	
3	R5	51R/0805/J	Resistor	1	
4	R6	10K/0805/F	Resistor	1	
5	R7	100K/1206/J	Resistor	1	
6	R8	2.5R/1206/J	Resistor	1	
7	R9	2.5R/1206/J	Resistor	1	
8	R10	10R/0805/J	Resistor	1	
9	CB1	104/400V CBB PIN:10mm	Capacitor	1	
10	C1	10uF 0805 25V	Capacitor	1	
11	C2	1uF 1206 25V	Capacitor	1	
12	C4	63uF 100V 8*12mm 105°C 8000H	Capacitor	1	
11	DB1	DB106S 1A600V	BRIDGE	1	
12	CX1	104/275V CX2 PIN:10mm	Capacitor	1	104/340V (for 300Vac)
13	D1	1N4148 LL34 SOT-123	Diode	1	
14	D2	51V 1/2W LL34 Glass Package	Diode	1	Optional
15	D3、D4	ES1J 1A/600V SMA	Diode	2	
16	Q2	MOSFET 4A/600V TO-251	MOSFET	1	
17	L2	EE12 30mH Common Mode	Choke	1	
17	T1	EE13 2mH±6%	Choke	1	
18	RV1	7D 471 PIN: 5mm	MOV	1	
19	F1	1A/250V Slow 3.6*10mm	FUSE	1	
20	PCB	PCB : FR-4 L45mm*W24mm*T1.6mm	PCB	1	
21	U1	SQ6211 SOT-26	IC	1	

Inductor Details



Winding	Wire	Pin	Turns	Tape
N1	2UEW, Ø0.20	6-7	170Ts	1T
N2	2UEW, Ø0.15	3-4	39Ts	2Ts

Figure 6. Picture of Top Side of the Power Module

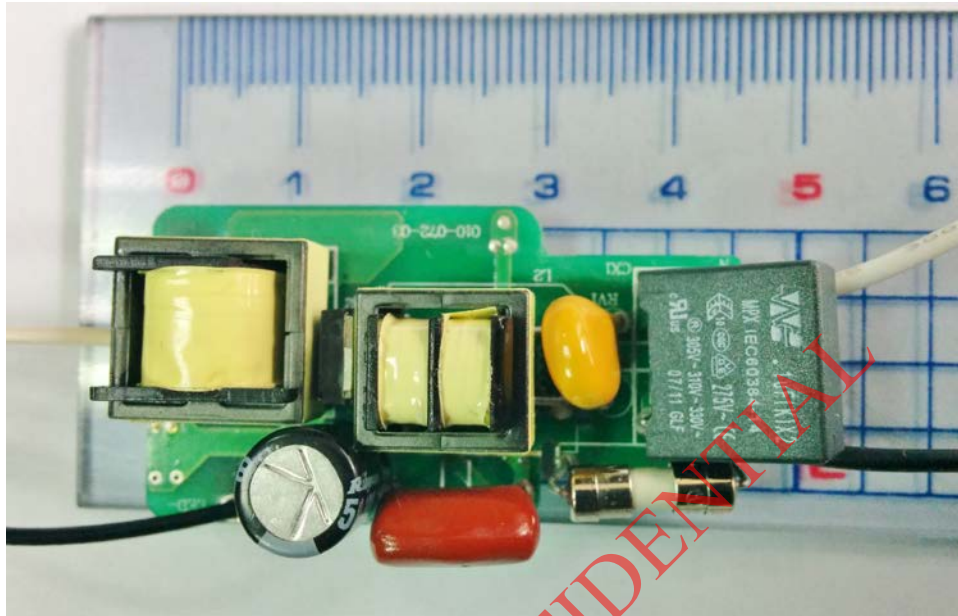

Figure 7. Picture of Bottom Side of the Power Module

